

balaustre
scale per interni
facciate in vetro
coperture scorrevoli
pensiline in vetro
porte in vetro

LA FORMA NATURALE DELL'ARTE

BALAUSTRE IN VETRO

la forma naturale dell'arte 2



balastra

NINFA

Designer / Fabrizio Zeponi . Nino Faraone

La famiglia NINFA 2015 / Designer: Nino Faraone . Matteo Paolini . Roberto Volpe

BALAUSTRE IN VETRO

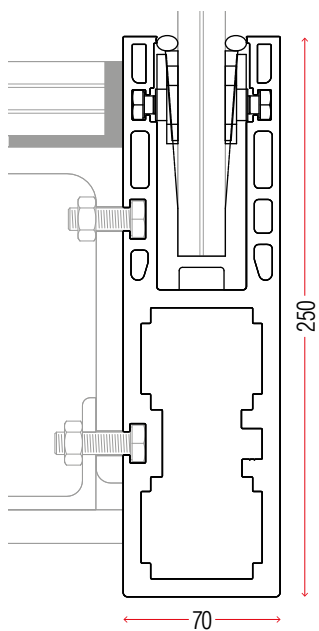

Ninfa Balcone

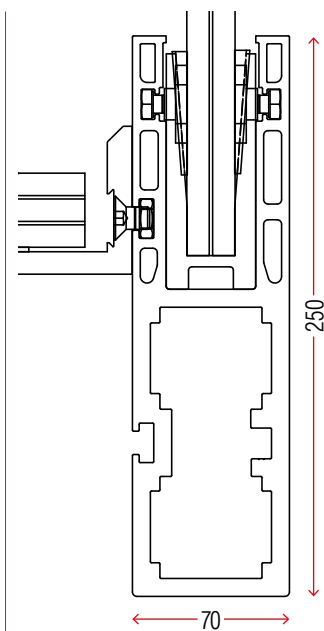

Ninfa Scala

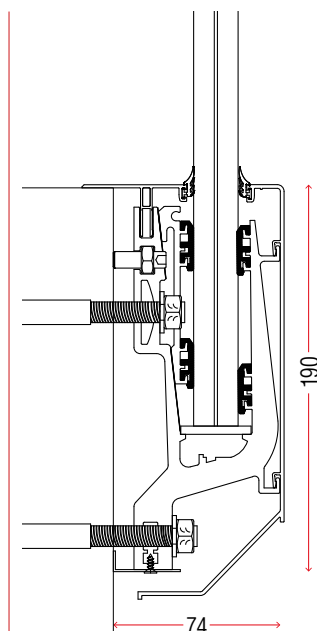

Ninfa 190

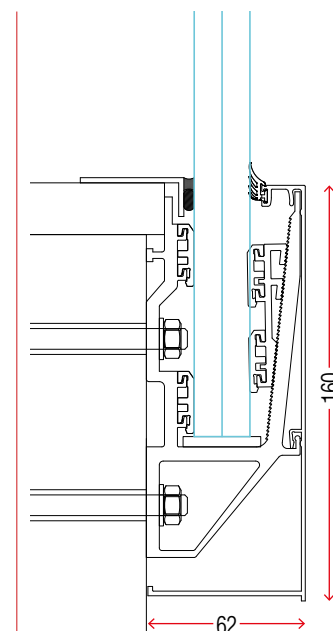

Ninfa 170

4 la forma naturale dell'arte

Ninfa 3



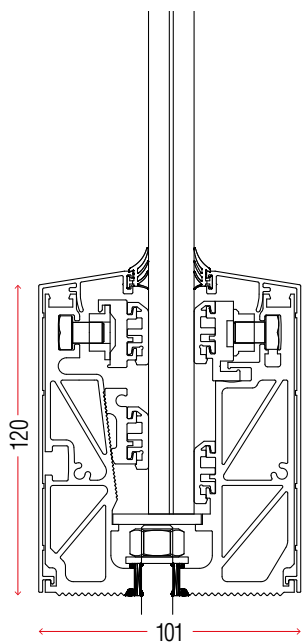

Ninfa 3

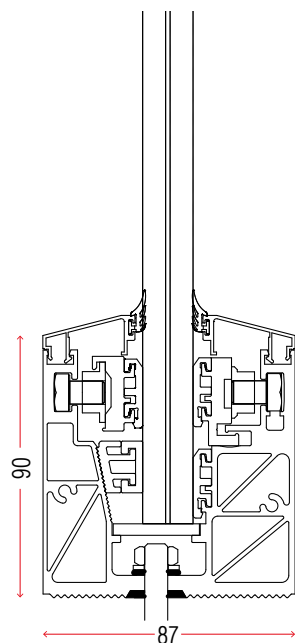

Ninfa 90

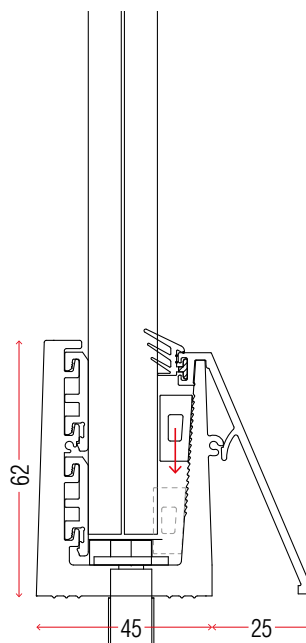

Ninfa 50

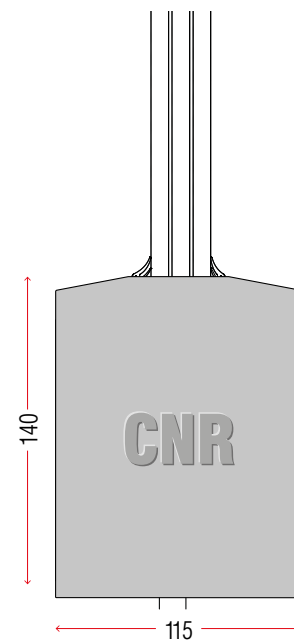

Ninfa 3.3 (A Norma Cnr Dt 210/2013 Cap.3)



balaustra
NINFA

Edificio residenziale / Lugano . Svizzera

BALAUSTRINE IN VETRO



la forma naturale dell'arte

Ninfa 3





Maior 60 Vision

BALAUSTRINE IN VETRO

7



Ninfa 3

la forma naturale dell'arte



Ninfa 50

Il più piccolo della famiglia!
Vetro fino a 80 cm di altezza certificato 200 Kg/m.



Ninfa 50

Ideale per la protezione su piscine con altezza vetro cm 100 (classe 100 Kg/1Kn) e mini passamano sopra.



NINFA 170

Basta un muretto di 20 cm e addio alle infiltrazioni d'acqua.

Sistema valido solo per montaggio su lato interno del muretto.



la giusta soluzione per nuove costruzioni
e ristrutturazioni

NINFA BALCONE

- . struttura con profilo in alluminio (colori RAL);
- . zero ponti termici;
- . soluzione antisismica;
- . pavimenti a scelta: vetro antiscivolo, marmo, ceramica, legno, etc;
- . balaustra in vetro o altri pannelli a norma;
- . controsoffitto a scelta: vetro luminoso o opaco, legno o altri pannelli a norma;
- . raccolta acque a progetto.

**Pronto per la posa e completo di viti di
fissaggio certificate.**
Preventivo a progetto e consegna 60 gg.





SEZIONE A-A

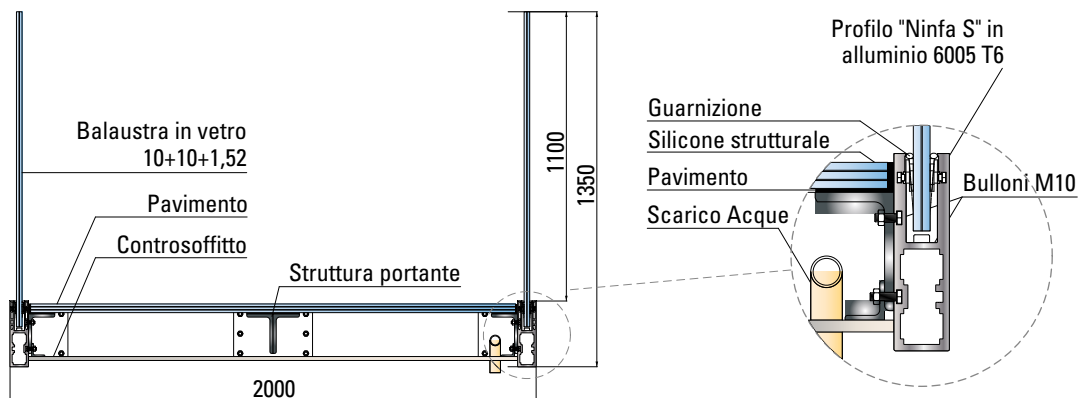
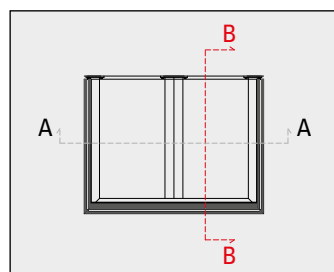

SEZIONE B-B

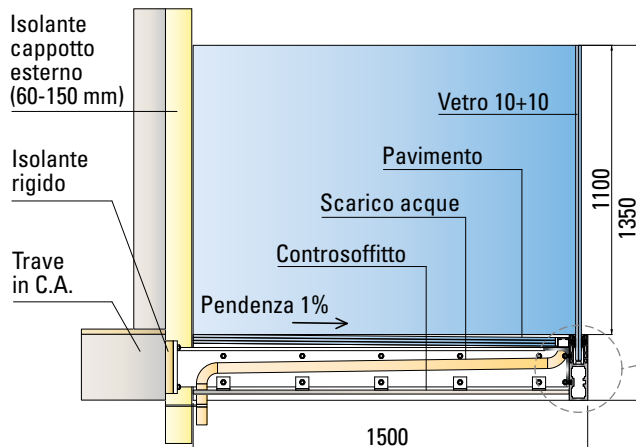

**SOLUZIONE 1
SCARICO NASCOSTO**

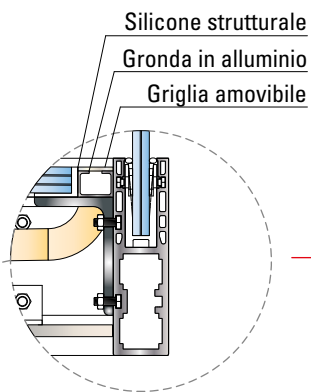

**SOLUZIONE 2
SCARICO A VISTA**

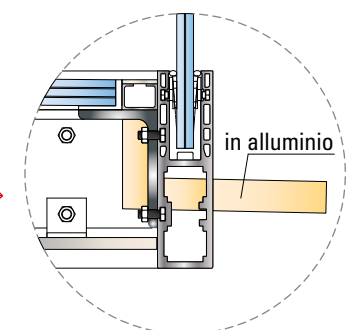

Mod. Iris
Acciaio INOX



Mod. Atena
Acciaio INOX



balaustra in vetro

NINFA CURVA

Progettato per qualsiasi raggio di curvatura da un minimo di 80 cm.

**Pronto per la posa e completo di viti di fissaggio certificate.
Preventivo a progetto e consegna 60 gg.**



Mod. Minerva
Acciaio INOX



Mod. Yuma
Acciaio INOX



Mod. ALBA-ALU

In alluminio simil inox



Mod. ALBA-INOX

In acciaio inox



Mod. ALBA-INOX 60

In acciaio inox

Mod. ALBA-QUADRO 60

In acciaio inox





balastra in vetro
ALBA



Maior
COLORS





BALAUSTRRE IN VETRO

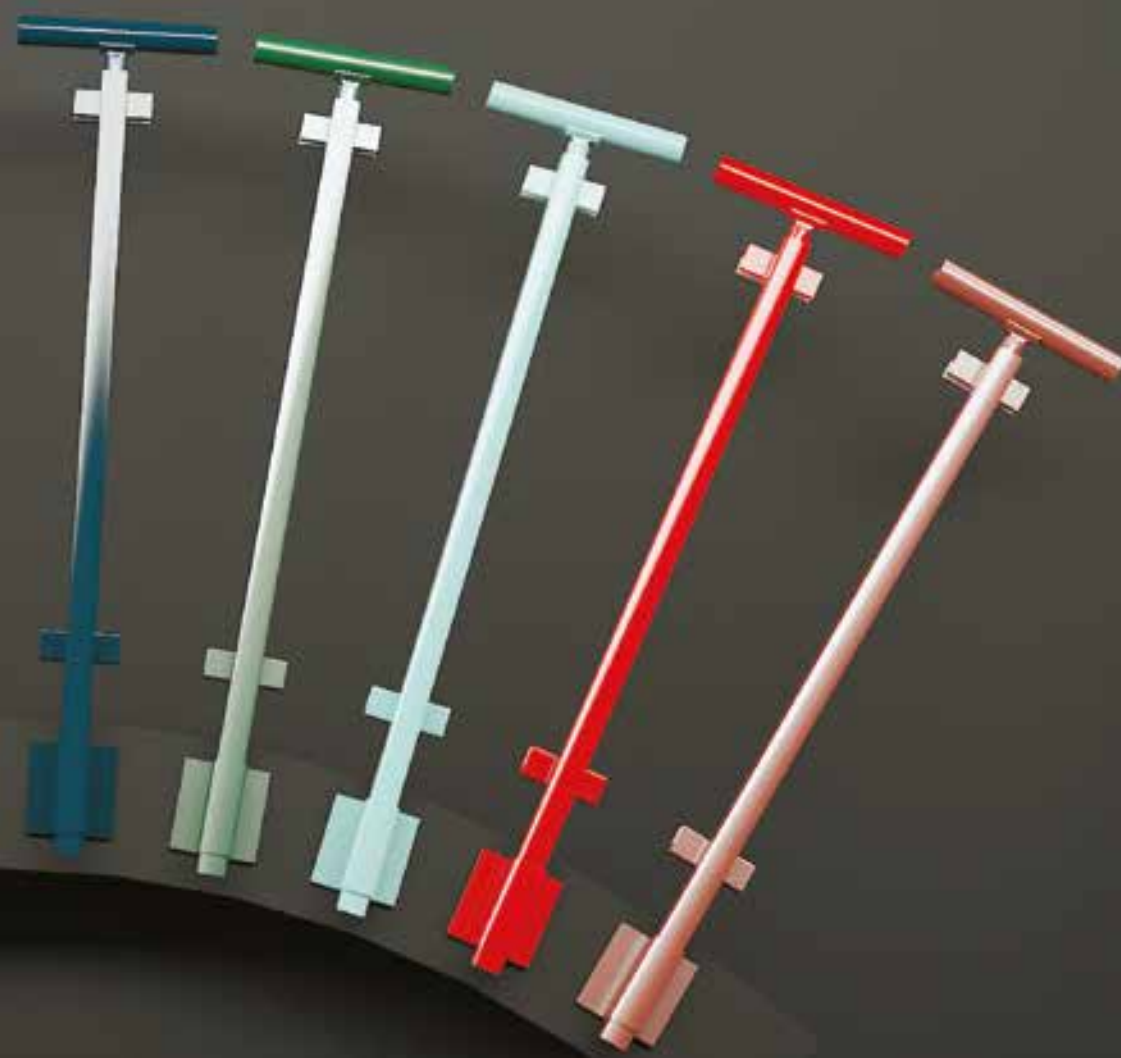

A

MAIOR ONE con fissaggio a pavimento con vetro esterno, utilizzabile sia per uso esterno che interno.

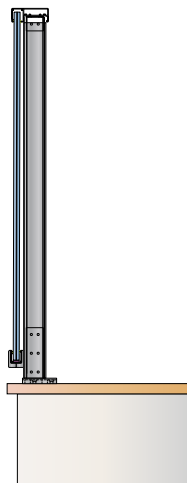
**B**

MAIOR ONE con fissaggio laterale con vetro esterno a tutta altezza, adatto per uso esterno.

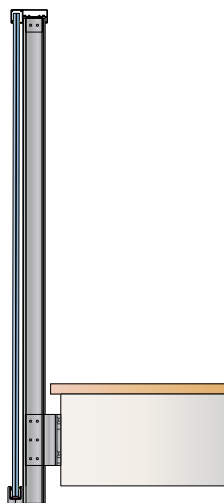
**C**

MAIOR ONE con fissaggio laterale con vetro interno, ideale per ballatoio in uso esterno e interno.

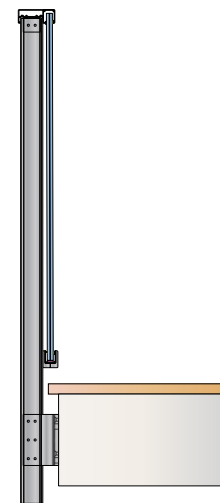
**importante!****ALTEZZA PIANTONE di serie 102 cm**

Misura su richiesta 112 cm (in lombardia è obbligatoria dal 3° piano) - Altre misure su richiesta.

Maior One

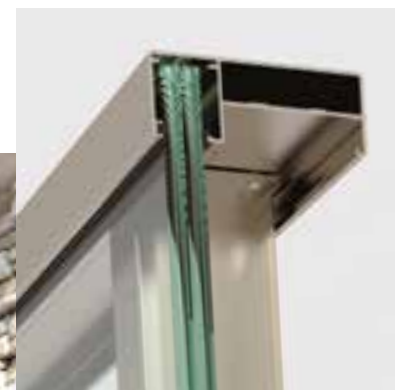

A

MAIOR PLUS con fissaggio a pavimento e vetro esterno, utilizzabile sia per uso esterno che interno.

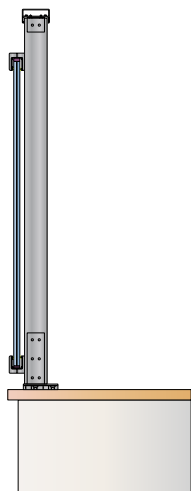

B

MAIOR PLUS con fissaggio laterale con vetro esterno a tutta altezza, adatto per uso esterno.

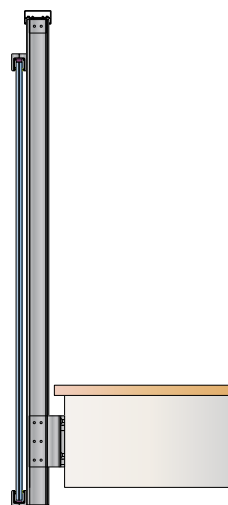

C

MAIOR PLUS con fissaggio laterale con vetro interno, ideale per ballatoio in uso esterno e interno.

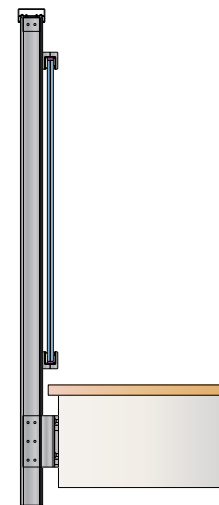

importante!

ALTEZZA PIANTONE di serie 102 cm

Misura su richiesta 112 cm (in lombardia è obbligatoria dal 3° piano) - Altre misure su richiesta.

Maior Plus



A

MAIOR VISION con
fissaggio a pavimento
con vetro esterno,
utilizzabile sia per uso
esterno che interno.

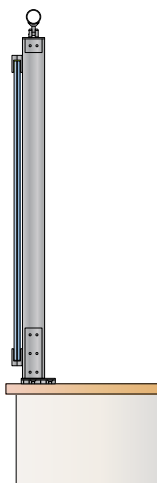
**B**

MAIOR VISION con
fissaggio laterale
con vetro esterno a
tutta altezza, adatto
per uso esterno.

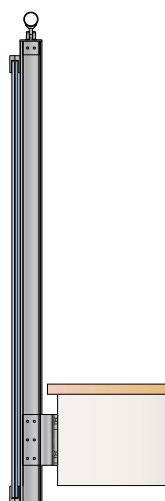
**C**

MAIOR VISION con
fissaggio laterale
con vetro interno,
ideale per ballatoio
in uso esterno e
interno.

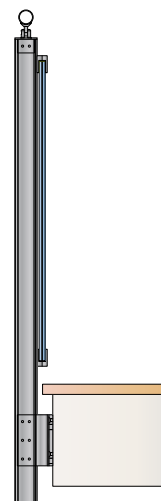
**D**

MAIOR VISION con
fissaggio laterale
con vetro interno
ideale per garantire
una maggiore sicurez-
za per
i bambini nella solu-
zione su scalinata.
Si usa per interno ed
esterno.

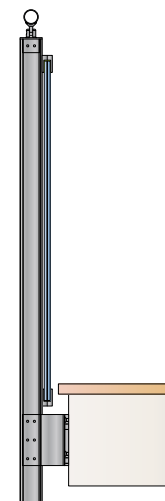
**importante!****ALTEZZA PIANTONE di serie 102 cm**

Misura su richiesta 112 cm (in lombardia è obbligatoria dal 3° piano) - Altre misure su richiesta.

Maior Vision



20

la forma naturale dell'arte



A

MAIOR 60 LINE
con fissaggio a pavimento
e vetro esterno,
utilizzabile sia per uso
esterno che interno.

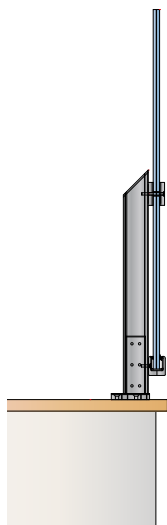

B

MAIOR 60 LINE con
fissaggio laterale e vetro
esterno a tutta altezza,
adatto per uso esterno.

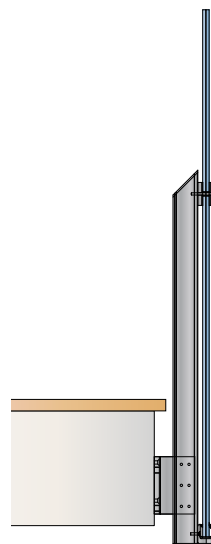

C

MAIOR 60 LINE con
fissaggio laterale e vetro
interno, ideale per ballatoio
in uso esterno ed interno.

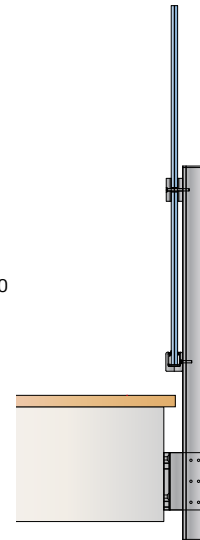

importante!

ALTEZZA PIANTONE di serie 102 cm

Misura su richiesta 112 cm (in lombardia è obbligatoria dal 3° piano) - Altre misure su richiesta.

Maior 60 Line



Vetro Extra Chiaro*

LED Multicolor / FARAONE.

**il alternativa al vetro Lumen con luce più intensa sul bordo della lastra.*

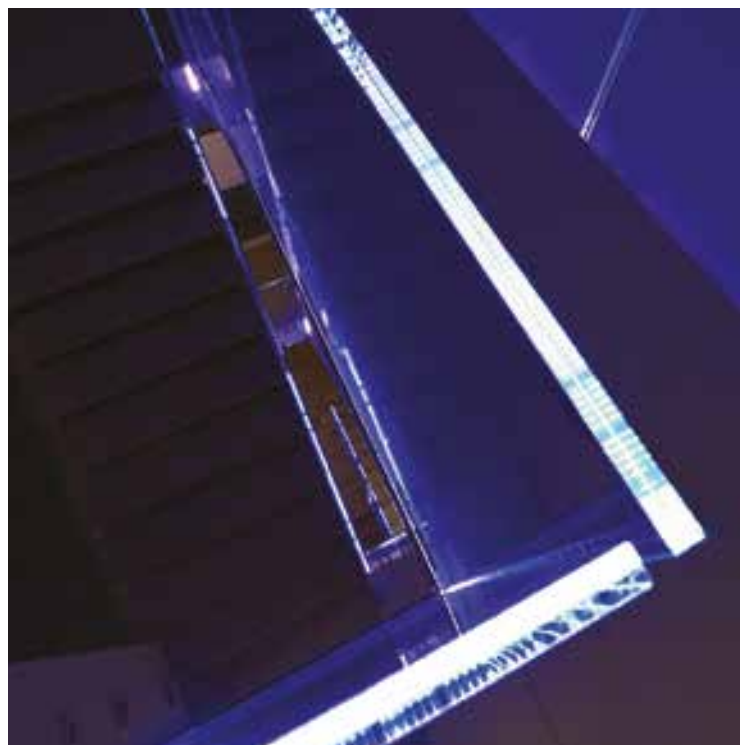

VETRO LUMEN

Il vetro che si illumina, con la stessa densità, fino ad una profondità di 1 metro.

L'emozione della luce con la praticità e bellezza del vetro, LED Multicolor / FARAONE.

Il vetro Lumen può essere fornito da LABORVETRO o da altre vetriere che ne fanno richiesta.





Designer / arch. Massimo Iosa Ghini

BALAUSTRINE IN VETRO

23

la forma naturale dell'arte



MOD. IMPERIALE
Sede Finmeccanica / Roma



Ninfa S





MOD. TITANIA
Billionaire / Istanbul . Turchia



SCALE



Ninfa S

25

la forma naturale dell'arte





ESSENZA 1

Struttura su misura in alluminio a trave singola con balaustre e gradini in varie finiture e materiali.

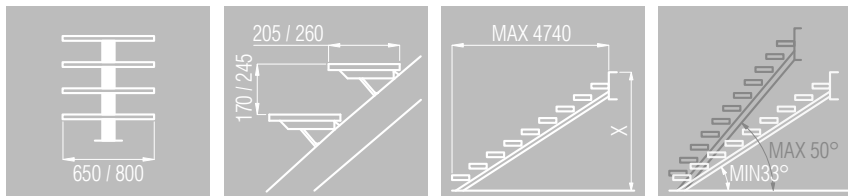

MIN / MAX

PER RICHIESTE DI PREVENTIVO FORNIRE:

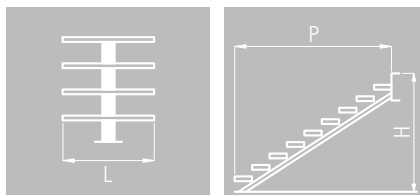

GRADINI:

- solo vetro;
- solo legno;
- con profilo in alluminio;
- con profilo in alluminio e superficie in vetro opaco o colorato;
- con profilo in alluminio e superficie in legno;
- con profilo in alluminio e superficie in marmo;
- con profilo in alluminio e superficie in moquette.

BALAUSTRE:

- in alluminio;
- in vetro;
- in acciaio inox



ESSENZA 2

Struttura su misura in alluminio a trave doppia con balaustre e gradini in varie finiture e materiali.

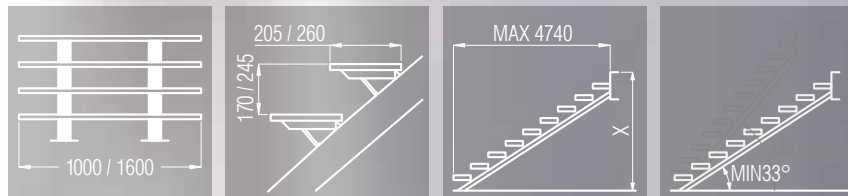

MIN / MAX

PER RICHIESTE DI PREVENTIVO FORNIRE:

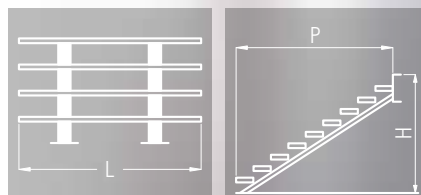

GRADINI:

- solo vetro;
- solo legno;
- con profilo in alluminio;
- con profilo in alluminio e superficie in vetro opaco o colorato;
- con profilo in alluminio e superficie in legno;
- con profilo in alluminio e superficie in marmo;
- con profilo in alluminio e superficie in moquette.

BALAUSTRE:

- in alluminio;
- in vetro;
- in acciaio inox



Essenza 1

Struttura su misura in alluminio, a trave singola, con gradini in legno e balaustre in alluminio.

Centro commerciale
 Long Island . New York



SCALE

31



la forma naturale dell'arte

facciata

KLIMA

La nuova facciata in vetro con fissaggio puntuale e vetri camera fino a 3 lastre è progettata per rispondere alle indicazioni "CasaClima" garantendo altissime prestazioni sul risparmio energetico e l'abbattimento acustico.

Il progetto Klima risponde all'attuale situazione economica offrendo alte prestazioni a costi contenuti.

KLIMA CON 2 VETRI
 UcW 1,1 w/m²K

KLIMA CON 3 VETRI
 UcW 0,8 w/m²K



Vince il Silver A' Design Awards 2014 nella categoria "Building Materials, Construction Components, Structures & Systems Design", design Roberto Volpe.



spazio allo stile

CRUISE

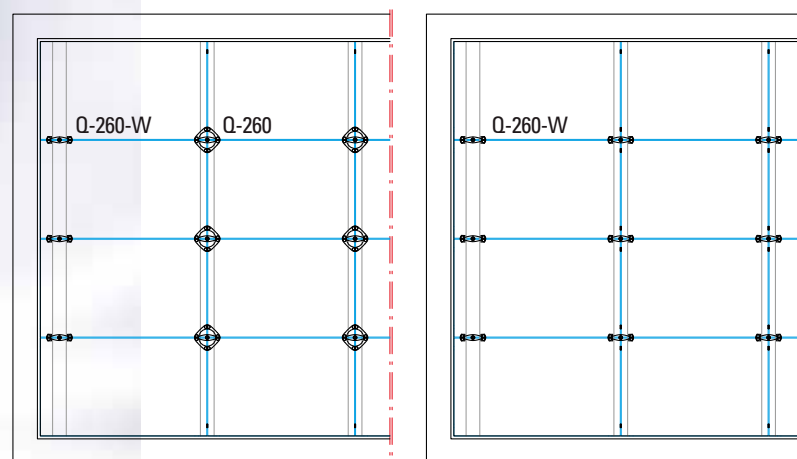
Una nuova gamma Air System CRUISE in cui si usa solo la crociera senza la rotula, con vetro stratificato non temperato (temperato se necessario) e montato solo in appoggio. La nuova crociera è disponibile in acciaio inossidabile AISI 316 lucido o satinato su richiesta.



L'ufficio tecnico FARAONE è disponibile a fornire l'eventuale assistenza tecnica a voi necessaria.



la crociera italiana
LOTO

Gamma Air System LOTO con nuovo design. La gamma Air System 2013 è sempre in acciaio inossidabile AISI 316 realizzata con il procedimento di microfusione a cera persa, lucidate a spazzola per ottenere una finitura lucida. (finitura satinata su richiesta).

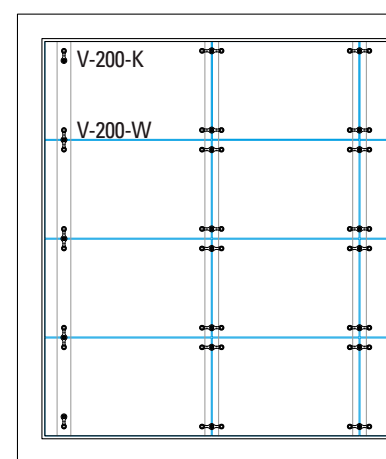
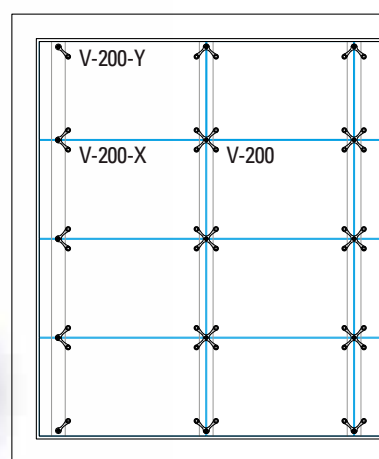

L'ufficio tecnico FARAONE è disponibile a fornire l'eventuale assistenza tecnica a voi necessaria.

architetture trasparenti / faraone.it

ACCESSORI IN ACCIAIO INOX PER FACCIAE IN VETRO CON FISSAGGIO PUNTUALE



per altezze fino a circa 5 metri
(senza rinforzo interno).

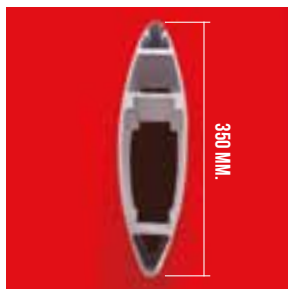

per altezze fino a circa
10 metri (senza rinforzo interno).



Ignarra Motors / Frosinone . Italia
faraone.it / architetture trasparenti

Concessionaria Ferrari / Roma



Negozio Champion / Alcamo . Trapani



Sede Grasso Group / Roma





design: Arch. Cosimino Casterini
Arch. Sabrina Romani

VIVERE A CONTATTO CON LA NATURA.

copertura scorrevole ad
impacchettamento per
residenze private:
la tua casa «decappottabile».





Ristorante Union Rooftop /
Minneapolis . USA



**COPERTURE
SCORREVOLI AD
IMPACCHETTAMENTO
TOTALE: MANUALI O
MOTORIZZATE.**



Residenziale / California . USA

COPERTURE SCORREVOLI



39

Arma n... e... a... a...

Zeytin Cafè / Istanbul . TURCHIA



Ristorante / Konya . TURCHIA





Ristorante / Abu Dhabi . UAE

SALISCENDI PANORAMICI MOTORIZZATI.

The Darkhill Hotel
Istanbul . TURCHIA



Sistema finestra saliscendi

Sistema finestra saliscendi

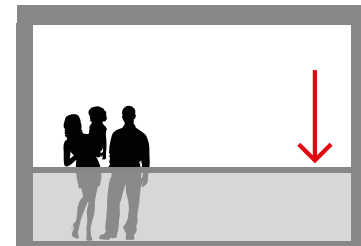
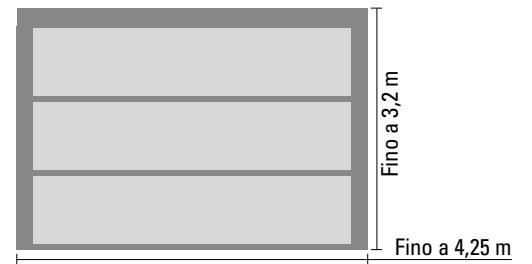

Sistema porta saliscendi

Sistema porta saliscendi

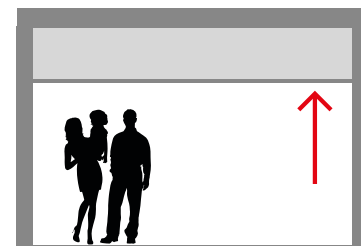
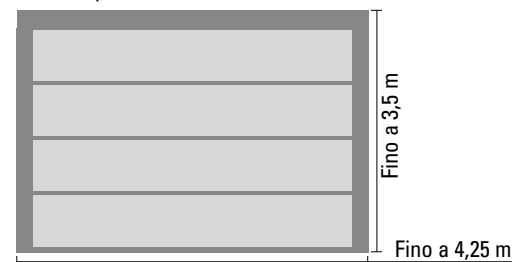

100 anni di garanzia sui materiali.

(salvo rottura accidentale del vetro)

pensilina modello GRANSASSO

Tondini in acciaio inox AISI 316 e accessori in alluminio colore argento. Vetro 6+6+1,52 temperato e stratificato. Gronda in alluminio di serie. Portata certificata fino a 130 Kg/mq escluso il peso del vetro.

articolo	misure cm.
PEN 2.B.2.	L.160 x H.120
PEN 2.B.3.	L.200 x H.120

La fornitura dei vetri è prevista solo per misure standard.

pensilina modello CLOCK

Struttura in acciaio inox AISI 304 con finitura lucida. Vetro 6+6+1,52 PVB temperato e stratificato. Portata certificata fino a 200 Kg/mq. escluso il peso del vetro.

articolo	misure cm.
CLOCK uno	L.160 x H.120
CLOCK due	L.200 x H.120
CLOCK tre	L.160 x H.150
CLOCK quattro	L.200 x H.150

Gronda in alluminio a richiesta: 34,00 euro/ml.
La fornitura dei vetri è prevista solo per misure standard.

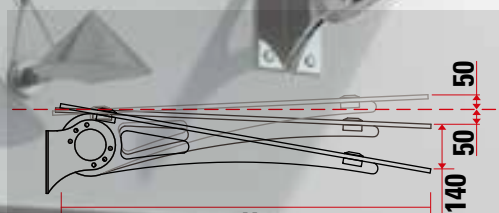

inclinazione registrabile

pensilina modello **LINEA**

la Pensilina "Linea" si compone di profilo in alluminio (pesante) anodizzato argento, vetro temperato e stratificato 10+10+1,52 ed è completo di tutti gli accessori per il fissaggio (escluso chimico). Portata certificata fino a 200 Kg escluso il peso del vetro.

articolo	misure cm.	vetro
Linea uno	L.150 x H.120	10+10+1.52 PVB
Linea due	L.200 x H.120	10+10+1.52 PVB
Linea tre	L.150 x H.150	10+10+1.52 SGB**
Linea quattro	L.200 x H.150	10+10+1.52 SGB**

Trasmette la stessa intensità di luce fino ad una profondità di 1 metro.

1 - Vetro Lumen

2 - Vetro normale (stesso LED usato per Lumen)



PENSILINE

45

pensilina modello **SFERA-N**

Struttura in acciaio inox AISI 316 con finitura lucida. Vetro 6+6+1,52 temperato e stratificato. Portata certificata fino a 200 Kg/mq escluso il peso del vetro.

articolo	misure cm.
PEN 1.2-N	L.160 x H.120
PEN 1.3-N	L.200 x H.120
PEN 1.4-N	L.160 x H.150
PEN 1.5-N	L.200 x H.150

La fornitura dei vetri è prevista solo per misure standard.



la forma naturale dell'arte



Chiudiporta idraulico invisibile **ZENIT SC**

Il chiudiporta "invisibile" idraulico a stelo verticale per porte in vetro ad azione singola. Facile e veloce da installare ZENIT SC è utilizzabile su vetro da 10 e 12 mm di spessore.



Chiudiporta idraulico invisibile **ZENIT D**

Chiudiporta idraulico a stelo verticale per porte in vetro a doppia azione.

Il sistema comprende tutti gli accessori per le soluzioni con sopra-luce e laterali fissi, i profili in alluminio sono disponibili nelle finiture standard (argento satinato) e altri colori su richiesta.

ZENIT D è utilizzabile su vetro da 10 e 12 mm di spessore.

Studio
55

**Il PRIMO maniglione con
serratura elettrica incorporata
ROYAL**

Progettista / Giuseppe Mirabella

Serratura elettrica inserita nel maniglione, completa di
quadro elettrico, batteria di riserva.
Apertura con badge o telecomando, a richiesta.



**PORTA IN VETRO CON ELETTRO SERRATURA
(SOLUZIONE SU MURATURA)**

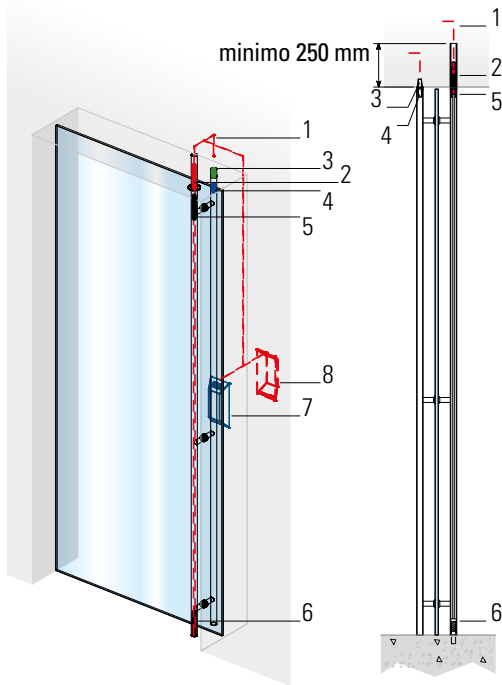

- 1) Alimentazione sistema
- 2) Elettro serratura inserita nel tubo
- 3) Sensore magnetico
- 4) Magnete
- 5) Perno di bloccaggio superiore
- 6) Perno di bloccaggio inferiore
- 7) Lettore badge/ricevitore radio
- 8) Scheda elettronica di gestione e controllo
(eventuale programmazione temporizzata)
con batteria tampone ai polimeri
di litio per emergenza

Alcune applicazioni dell'elettroserratura

ROYAL VERSIONE STANDARD

ROYAL-01-S
ROYAL-01-L

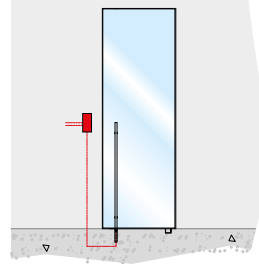

ROYAL-01-S-1
ROYAL-01-L-1

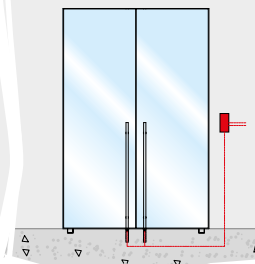

ROYAL VERSIONE SPECIAL

ROYAL-02-S-4
ROYAL-02-L-4

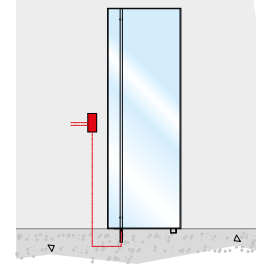

ROYAL-02-S-5
ROYAL-02-L-5

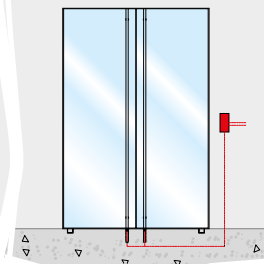

**PORTA IN VETRO CON ELETTRO SERRATURA
(SOLUZIONE CON SOPRALUCE)**

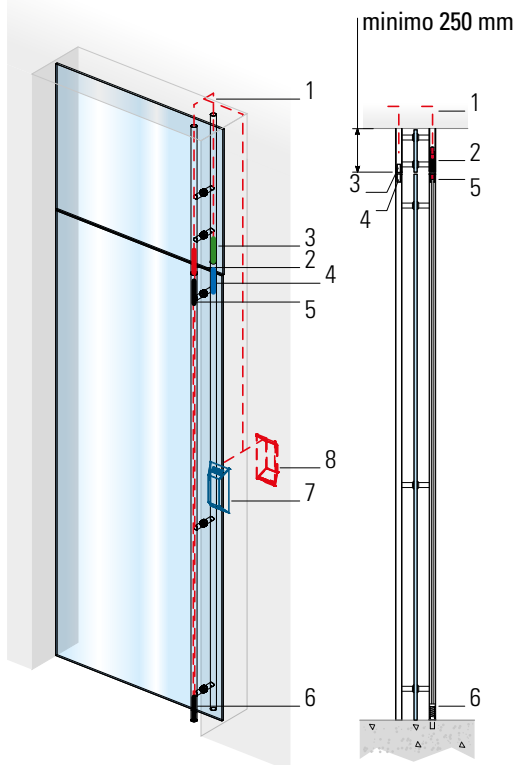

ROYAL-02-S
ROYAL-02-L

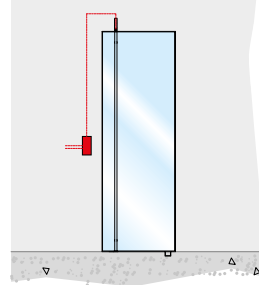

ROYAL-02-S-1
ROYAL-02-L-1

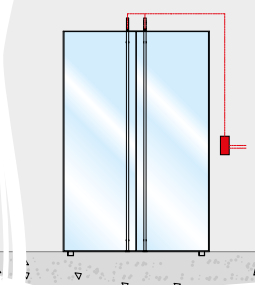

ROYAL-02-S-6
ROYAL-02-L-6

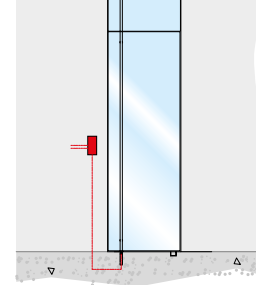

ROYAL-02-S-7
ROYAL-02-L-7

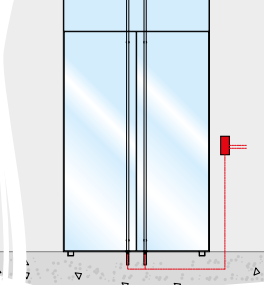

ROYAL-02-S-2
ROYAL-02-L-2

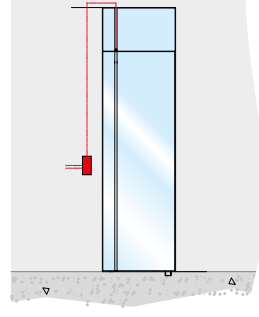

ROYAL-02-S-3
ROYAL-02-L-3

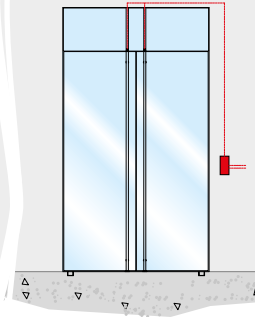

ROYAL-03-S
ROYAL-03-L

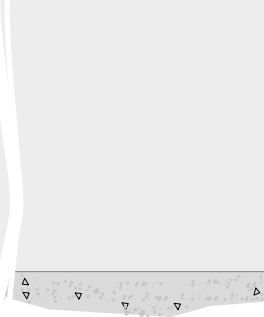
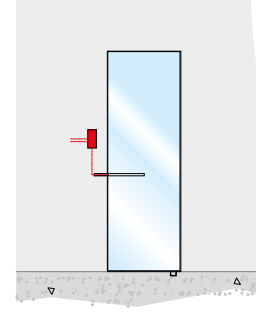



LA FARAONE È STATA LA PRIMA DITTA IN ITALIA A EVIDENZIARE E PROMUOVERE LE NORMATIVE SU BALAUSTRE E RINGHIERE.

Le normative sulla resistenza delle ringhiere (D.M. del 14/01/2008) non sono chiare!

La Faraone, nel 2011 tramite l'Uncsaal, ha interpellato il Ministero dei Lavori Pubblici che ha dichiarato, solo verbalmente, che: "le ringhiere devono avere una resistenza minima alla spinta di 200 Kg al metro lineare".

CAT. AMBIENTI	Qk [kN/m ²]	Qk [kN]	Hk [kN/m]
Ambienti suscettibili di affollamento Cat. C2 Balconi, ballatoi e scale comuni, sale convegni, cinema, teatri, chiese, tribune con posti fissi;	4,00	4,00	2,00
C Cat. C3 Ambienti privi di ostacoli per il libero movimento delle persone quali: musei, sale per esposizioni, stazioni ferroviarie, sale da ballo, palestre, tribune libere, edifici per eventi pubblici, sale da concerto, palazzetti per lo sport e relative tribune.	5,00	5,00	3,00

ESTRATTO DALLA GAZZETTA UFFICIALE

Solo nella categoria C2 / C3 si parla di balconi, scale comuni, etc. pertanto esistono solo resistenze da 200 e 300 Kg.

NEL 2014 SI SONO AGGIUNTE:
 - LA NORMA UNI 7697:2014 SUL POST ROTTURA;
 - LA NORMA DEL CNR DT 210/2013 (CAP. 13).

ATTENZIONE! LE NORMATIVE IN VIGORE IN ITALIA.

Le più restrittive al mondo sulle balaustre in vetro.

PRIMA

balaustra di
30 anni.

DOPO

balaustra nuova
mod. Maior Plus

LEGGE 220/2012 RIFORMA DEL CONDOMINIO

La recente riforma del condominio ha apportato **RILEVANTI** modifiche alla modalità di gestione, obblighi e **RESPONSABILITÀ DI AMMINISTRATORI** e condòmini.

DETRAZIONE DEL 50%

Sono ancora in vigore gli incentivi statali per la rottamazione delle vecchie ringhiere: approfittane!



VIVI A CONTATTO CON LA NATURA.

copertura scorrevole automatica
in vetro e alluminio:

la tua casa decappotabile

design: Arch. Cosimino Casterini / Arch. Sabrina Romani



FARAONE

FARAONE S.r.l.
VIA PO, 12
64018 TORTORETO (TE) ITALY
T. +39 0861.784200
F. +39 0861.781035

www.faraone.it
segreteria@faraone.it



SISTEMA DI GESTIONE QUALITÀ
UNI EN ISO 9001:2008
CERTIFICATO N°0841-243-Q



scelta di materie prime riciclabili come alluminio, acciaio e vetro.
Gestione dei propri rifiuti particolari secondo la normativa nazionale
(D.LGS. 152/2006 e SS.NN.II.)